

2-GTJ-2030 : JIG For FGDS12A LHUG150N MGDD40/MGDD80

2.1-Board Description

GTJ2030 is a test jig that can be used to evaluate converters from the MGDD40 or MGDD80 series, along with the LHUG150N input bus conditioner, and the FGDS12A100 EMI filter. Testing can be performed with regards to the Mil-STD1275, Mil-STD 704 and Mil-STD461 military standards. This Board is for evaluation only.

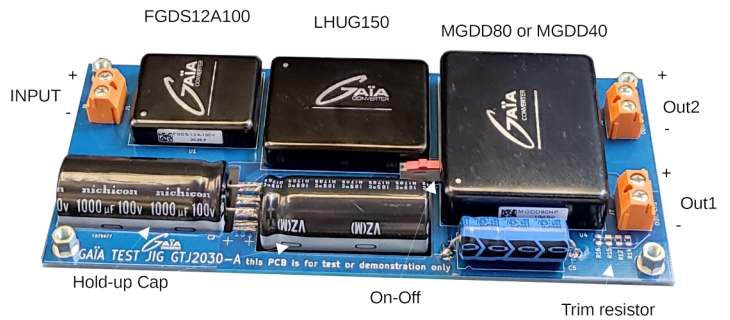

2.2-SCHEMATIC DIAGRAM

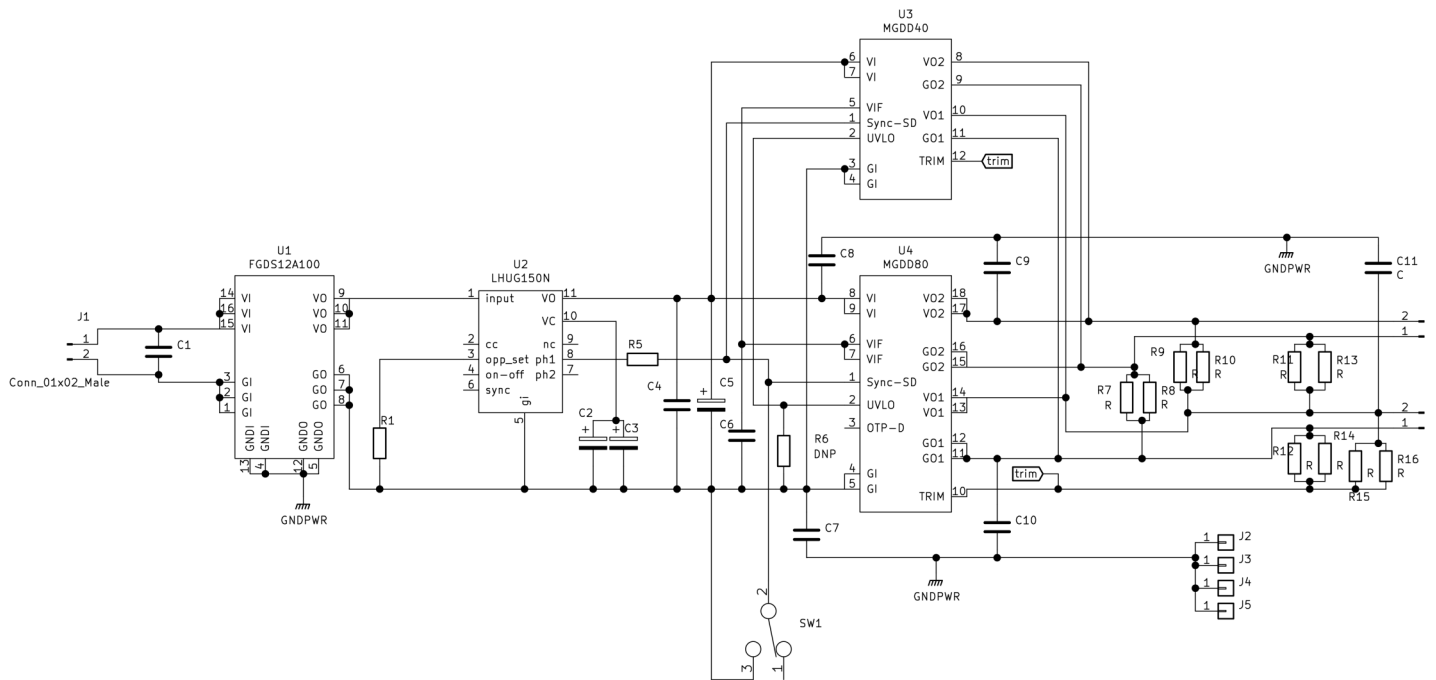

GTJ2030-A Schematic diagram
U3/U4 are double implantation components

2-GTJ-2030 : JIG For FGDS12A LHUG150N MGDD40/MGDD80

2.3-BOARD DRAWINGS

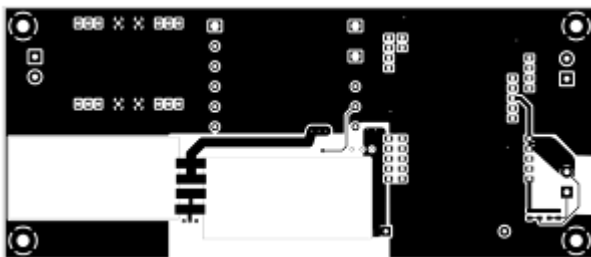
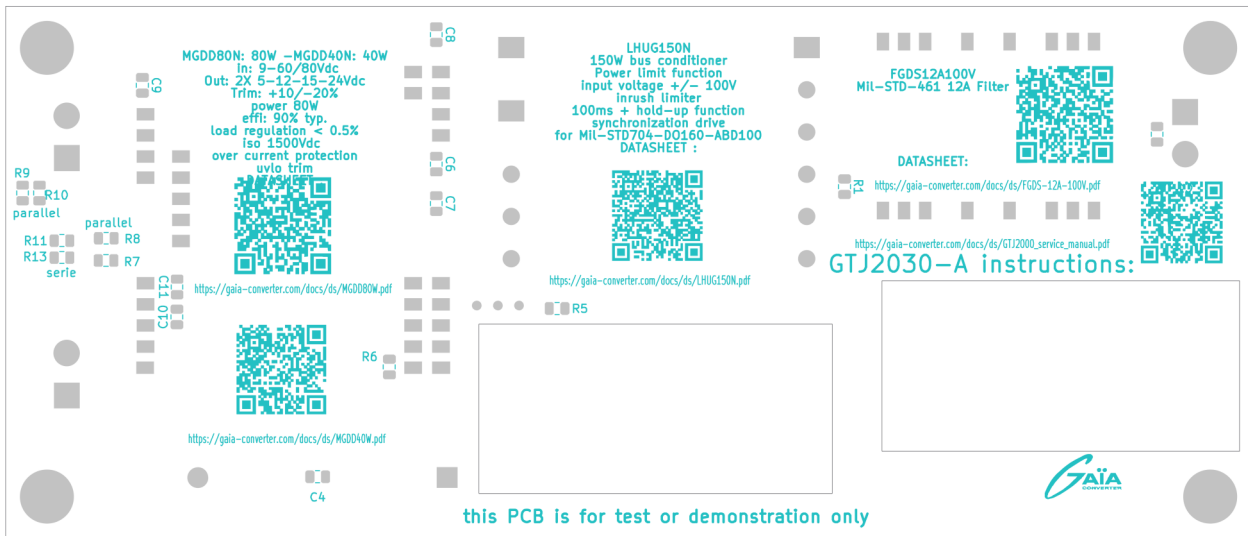
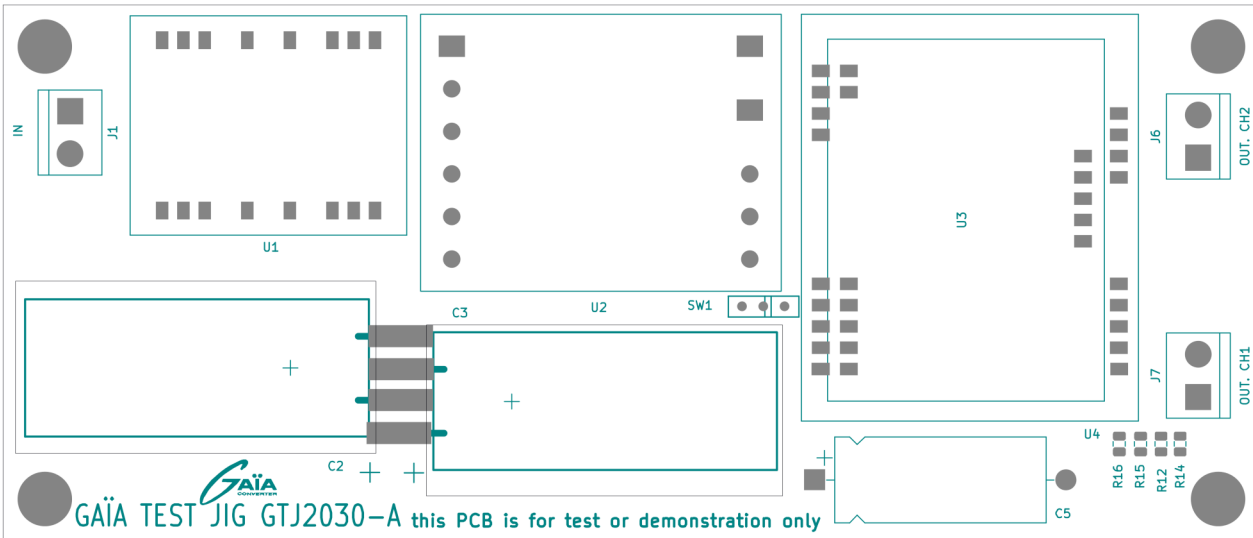

Copper top layer

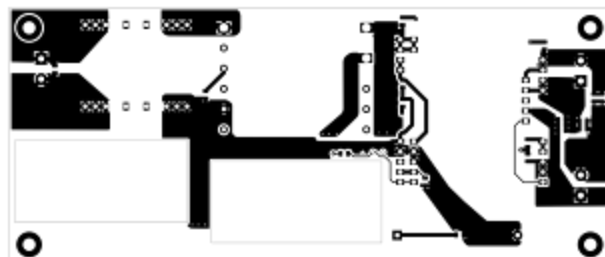

Copper bottom layer

GTJ2030-A

2-GTJ-2030 : JIG For FGDS12A LHUG150N MGDD40/MGDD80

2.3-BOARD DRAWINGS

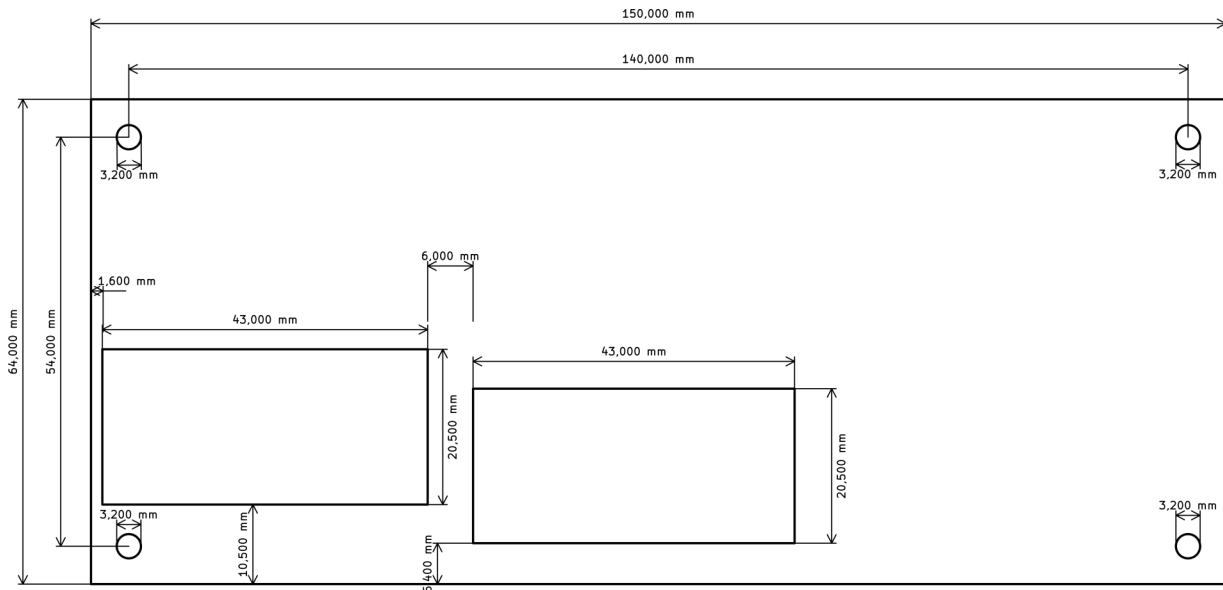

General tolerances +/- 0.2

PCB thickness : 1.6 mm

2-GTJ-2030 : JIG For FGDS12A LHUG150N MGDD40/MGDD80

2.4-BILL OF MATERIALS

designator	description	Quantity	possible part-number	Supplier	comment
C2,C3	1000µF 100V	2 (1)	UVZ2A102MHD	Nichicon	
C1,C4	100nF 100V MLCC	2	C0805C104J1RACTU	KEMET	
C5	100µF / 100V	1	107TTA100M	CORNELL DUBLIER	
C6	1µF 100V MLCC	1	08051C105KAT2A	AVX	
C7,C8,C9,C10	10nF MLCC	4	08051C103JAT2A	AVX	Warning not for 1500V isolation
R5, R7,R8, R9, R10,R11 ,R13	0 OHMS	7	CRCW08050000Z0EAHP	Vishay	Configuration straps
R1, R6 R12,R14,R15	Anny value	5	MCU08050D1001BP500	Vishay	Configuration resistors
J1,J7,J8	Terminal blocks	3	1760490000	WEIDMULLER	
SW1	Switch SIL 1 mm THT WS 10x2.5	1	45030101442	WURTH ELEKTRONIK	
U1	EMI FILTER 12A	1	FGDS12A100	GAIA-CONVERTER	
U2	INPUT BUS CONDITIONER	1	LHUG150N	GAIA-CONVERTER	Can be bypassed
U3/U4	40/80W DC/DC converter	1	MGDD40 MGDD80	GAIA-CONVERTER	

Bom is given as suggestion, any other components part numbers may suit.

2.5-COMPATIBLE MODULES

Compatible Modules	comment	Compatibles Modules	comment
MGDD40NB		MGDD80NB	
MGDD40NC		MGDD80NC	
MGDD40NE		MGDD80NE	
MGDD40NF		MGDD40NF	
MGDD40NI		MGDD40NI	
MGDD40NCE		MGDD40NCE	
MGDD40EC	With shunt instead of LHUG150	MGDD40EC	With shunt instead of LHUG150
MGDD40EE	With shunt instead of LHUG150	MGDD40EE	With shunt instead of LHUG150
MGDD40EF	With shunt instead of LHUG150	MGDD40EF	With shunt instead of LHUG150
MGDD40EI	With shunt instead of LHUG150	MGDD40EI	With shunt instead of LHUG150
FGDS12A100		LHUG150N	

2-GTJ-2030 : JIG For FGDS12A LHUG150N MGDD40/MGDD80

2.6-ASSEMBLY & OPERATION

Board Assembly : Start by populating smallest components (SMD resistors and SMD capacitors) on the bottom side of GTJ2030, and then on top side. Populate configuration resistors according to the desired output configuration (see table opposite). If R1 is not populated and LHUG150N used, the maximum power will be limited to ~30W at converters input. Populate then the 3 junction blocks, aluminum capacitors, and switch SW1. Gaia modules have to be populated at the last stage of assembly. **Warning :** The Hold-up Cap polarity may be confusing due to 2 crosses drawn on silk screen near the cap – connection. Installing sockets (E-TEC : BL1-036-G-700-1) in place of Gaia modules allow to use board as reusable test jig. Performances given behind are measured with modules Assembled without directly on board without sockets.

CONFIGURATION	COMPONENTS VALUE
Output channels in parallel	R7,R8,R9,R10 =0Ω R11, R13 =DNP
2 output channels independant	R7,R8,R9,R10 = DNP* R11, R13 =DNP
Output channels in series or +/- V	R7,R8,R9,R10 = DNP* R11, R13 =0Ω
Forbidden	R7,R8,R9,R10 = 0Ω R11, R13 =0Ω
Up to 120W power	R1 = 0Ω
Up to 120W power	R1 = DNP*

Board Operation : To operate the board, the wiring scheme opposite needs to be followed. The input Generator (or Lab. PSU) has to be connected to J1; LOAD#1, and LOAD#2 have to be connected respectively to J7 and J6. In case of connection in series the LOAD#3 scheme can be used. In case of connection in parallel, only LOAD#1 can be used.



2.7-EXPECTED PERFORMANCES

2.7.1-MIL-STD 1275 100V 50ms SURGE

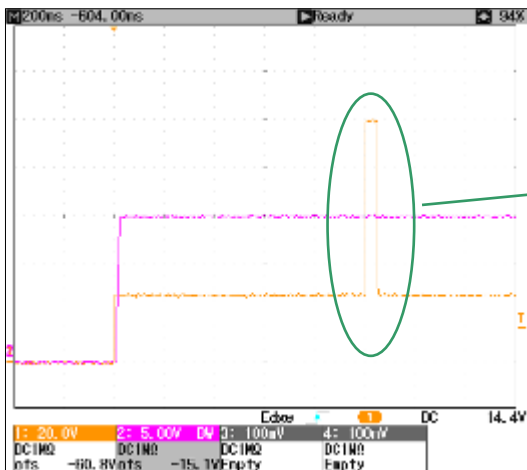

Ch1= 28V in Ch2 = 15V out

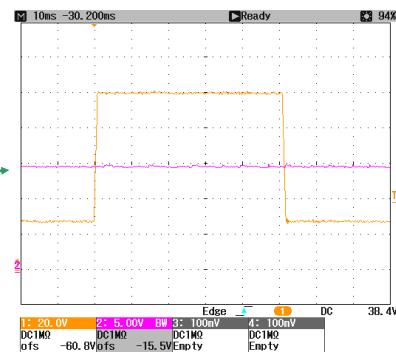

2-GTJ-2030 : JIG For FGDS12A LHUG150N MGDD40/MGDD80

2.7-EXPECTED PERFORMANCES (Continued)

2.7.2-MIL-STD 461 Audio Frequency Injection

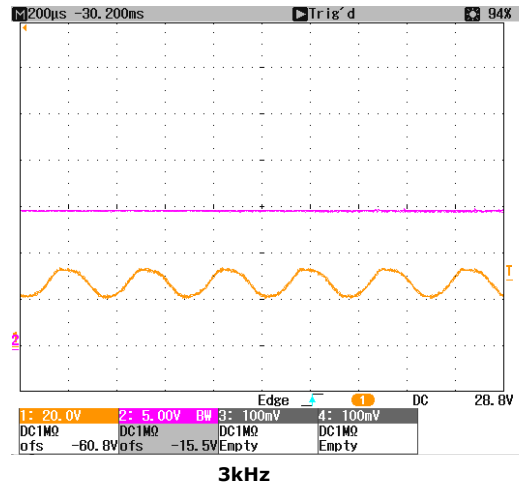
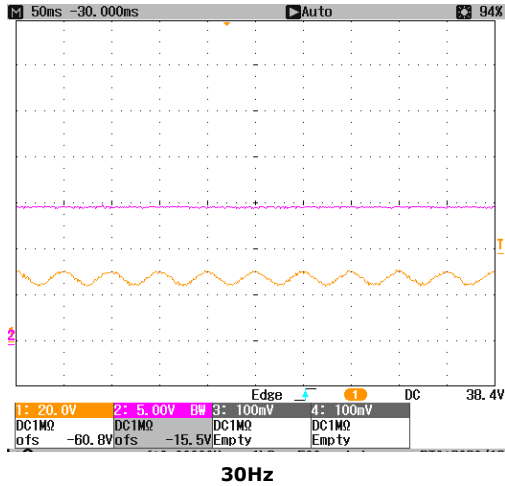

2.7.3-DO160 EMI Performances

