



TRH160A SERIES 160 WATT I.T.E SWITCH ADAPTER

Features

- Universal Input Range 90~264Vac
- High Efficiency up to 93%
- Class I
- No Load Input Power Consumption < 150mW
- Approval IEC/EN/UL 62368-1
- Approval EN55032 and CISPR/FCC Class B
- Meets IEC/EN 60335-1
- Operating Altitude 5000m
- Continuous Short Circuit Protection
- Over Voltage Protection
- Very Low Leakage Current <90uA
- Meets CoC Tier 2 and DOE Level VI
- IEC320/C14 Compact Size



MODEL NUMBER	OUTPUT VOLTAGE	OUTPUT CURRENT	RIPPLE & NOISE NOTE1	VOLTAGE ACCURACY NOTE2	LINE REGULATION NOTE3	LOAD REGULATION NOTE4	%EFF. (Typ.) NOTE5
TRH160A120	12 V	12.5 A	120mV	±2%	±1%	±3%	91%
TRH160A240	24 V	6.66 A	200mV	±2%	±1%	±2%	92%
TRH160A280	28 V	5.7 A	200mV	±2%	±1%	±2%	92%
TRH160A300	30 V	5.31 A	200mV	±2%	±1%	±2%	92%
TRH160A360	36 V	4.44 A	200mV	±2%	±1%	±2%	92%
TRH160A480	48 V	3.33 A	200mV	±2%	±1%	±2%	93%
TRH160A560	56 V	2.85 A	200mV	±2%	±1%	±2%	93%

Note:

1. Add a 0.1uF ceramic capacitor and a 10uF E.L. capacitor to output for ripple & noise measuring @20MHz BW.
2. Voltage accuracy is set at 60% full load.
3. Line regulation is measured from 100V_{ac} to 240V_{ac} with full load.
4. Load regulation measured from 60% to 100% full load and from 60% to 20% full load (60%±40% full load).
5. Typical efficiency at 230V_{ac} and 75% full load at 25°C.

PART NUMBER

Series		Output Voltage	DC Plug Type	Cable Type	Cable Length
TRH160	X	XXX	-XX	E	XX
160W I.T.E Adapter	A : Class I	120 : 12V	See Page 7	E : UL2464 with OVP	12V : 950mm with DIN Power Plug
		240 : 24V			24V : 1220mm with DC Jack
		280 : 28V			28V : 1800mm with DC Jack
		300 : 30V			30V : 1800mm with DC Jack
		360 : 36V			36V : 1800mm with DC Jack
		480 : 48V			48V : 1800mm with DC Jack
		560 : 56V			56V : 1800mm with DC Jack

Part Number Example:

TRH160A120-1446E471, 150W, Class I, 12V_{ac} Output, DIN Power Plug Type, Cable Length 950mm

TRH160A240-01E12, 160W, Class I, 24V_{ac} Output, DC Jack Type, Cable Length 1220mm



TRH160A Series

TECHNICAL SPECIFICATIONS

(All specifications are typical at nominal input, full load at 25°C unless otherwise noted.)

ABSOLUTE MAXIMUM RATINGS

PARAMETER	NOTES and CONDITIONS	Device	Min.	Typ.	Max.	Units
Input Voltage		All	90		264	V _{ac}
Operating Temperature	See Derating Curve, (-30°C Can be Start-up at full load.)	All	-20		70	°C
Storage Temperature		All	-40		85	°C
Input/Output Isolation Voltage	1 minute	All			3000	V _{ac}
Operating Altitude		All			5000	m

INPUT CHARACTERISTICS

PARAMETER	NOTES and CONDITIONS	Device	Min.	Typ.	Max.	Units
Operating Voltage Range		All	100		240	V _{ac}
Input Frequency Range		All	47		63	Hz
Maximum Input Current	100% Load, V _{in} =100V _{ac}	All			2.0	A
Leakage Current (Earth)		All			3.5	mA
Leakage Current (Touch)		All			90	uA
Under Voltage Protection		All	60	66	70	V _{ac}
Power Factor	230V _{ac} /50Hz at Full load	All	0.9			
Inrush Current	V _{in} =240V _{ac} , Cold start at 25°C	All			120	A

OUTPUT CHARACTERISTICS

PARAMETER	NOTES and CONDITIONS	Device	Min.	Typ.	Max.	Units
Output Voltage Set Point	V _{in} =115V _{ac} and 230V _{ac} , I _o =60% Full load T _c =25°C	TRH160A120	11.76	12	12.24	V _{dc}
		TRH160A240	23.52	24	24.48	
		TRH160A280	27.44	28	28.56	
		TRH160A300	29.4	30	30.6	
		TRH160A360	35.28	36	36.72	
		TRH160A480	47.04	48	48.96	
		TRH160A560	54.88	56	57.12	
Operating Output Current Range	V _{in} =115V _{ac} and 230V _{ac} , T _c =25°C	TRH160A120	0		12.5	A
		TRH160A240	0		6.66	
		TRH160A280	0		5.7	
		TRH160A300	0		5.31	
		TRH160A360	0		4.44	
		TRH160A480	0		3.33	
		TRH160A560	0		2.85	
Holdup Time	V _{in} =115V _{ac}	All		25		ms
Output Voltage Regulation						
Load Regulation	60%±40% Full load change	TRH160A120			±3.0	%
		TRH160A240			±2.0	
		TRH160A280			±2.0	
		TRH160A300			±2.0	
		TRH160A360			±2.0	
		TRH160A480			±2.0	
		TRH160A560			±2.0	
Line Regulation	V _{in} =High line to low line, full load	All			±1.0	%



TRH160A Series

PARAMETER	NOTES and CONDITIONS	Device	Min.	Typ.	Max.	Units
Over Voltage Protection	Latch Off (AC Recycle to Reset)	TRH160A120		13.2		V_{dc}
		TRH160A240		28.6		
		TRH160A280		33.4		
		TRH160A300		34.6		
		TRH160A360		41.8		
		TRH160A480		55.6		
		TRH160A560		59.8		
Over Current Protection	Auto recovery	All	110		125	%
Short Circuit Protection	Auto recovery	All				
Output Ripple and Noise	1. Add a 0.1uF ceramic capacitor and a 10uF aluminum electrolytic capacitor to output 2. Oscilloscope is 20MHz band width 3. Ambient temperature=25°C	TRH160A120			120	mV
		TRH160A240			200	
		TRH160A280			200	
		TRH160A300			200	
		TRH160A360			200	
		TRH160A480			200	
		TRH160A560			200	
Load Capacitance	1. $V_{in}=115V_{ac}$ and $230V_{ac}$ 2. Output is max. load 3. Ambient temperature=25°C	TRH160A120			12250	uF
		TRH160A240			6600	
		TRH160A280			5670	
		TRH160A300			5400	
		TRH160A360			4330	
		TRH160A480			3240	
		TRH160A560			2870	
Efficiency	1. $V_{in}=230V_{ac}$ 2. Output is 75% full load 3. Ambient temperature=25°C	TRH160A120		91%		%
		TRH160A240		92%		
		TRH160A280		92%		
		TRH160A300		92%		
		TRH160A360		92%		
		TRH160A480		93%		
		TRH160A560		93%		

ISOLATION CHARACTERISTICS

PARAMETER	NOTES and CONDITIONS	Device	Min.	Typ.	Max.	Units
Input to Output	1 minute (without dielectric breakdown)	All			3000	V_{ac}
Input to Earth (Ground)	1 minute (without dielectric breakdown)	All			1500	V_{ac}
Isolation Resistance	Input to output	All	100			MΩ

FEATURE CHARACTERISTICS

PARAMETER	NOTES and CONDITIONS	Device	Min.	Typ.	Max.	Units
Switching Frequency		All		110		kHz

GENERAL SPECIFICATIONS

PARAMETER	NOTES and CONDITIONS	Device	Min.	Typ.	Max.	Units
MTBF	$I_o=100\%$; $T_a=25^\circ C$ per MIL-HDBK-217F	All	300			k hours
Humidity	Non-condensing	All			93	% RH
Shock	MIL-STD-810F Table 516.5, TABLE 516.5-I 10ms, each axis 3 times($\pm X$ 、 $\pm Y$ 、 $\pm Z$ axis)	All		75		g
Vibration	MIL-STD-810F Table 514.5C-VIII, 15~2000Hz, X、Y、Z axis, 1 hour(each axis),. total 3 hours.	All		4		g
Weight		All		575		grams



TRH160A Series

GENERAL SPECIFICATIONS

PARAMETER	NOTES and CONDITIONS	Device	Min.	Typ.	Max.	Units
Dimension		All	5.906x2.756x1.497 inches (150.00x70.00x38.00 mm)			
Safety	Class I, IEC62368-1:2014 EN62368-1:2014+A11 UL 62368-1, 2nd Edition					Ed 2.0
EMC Emission	EN55032:2015+AC:2016, EN61000-3-2:2014, EN61000-3-3:2013, FCC CFR 47 Part 15					
Conducted Disturbance	EN55032:2015+AC:2016, FCC CFR 47 Part 15					Class B
Radiated Disturbance	EN55032:2015+AC:2016, FCC CFR 47 Part 15					Class B
Harmonic Current Emissions	EN61000-3-2:2014					Class A
Voltage Fluctuations & Flicker	EN61000-3-3:2013					Criterion A
EMC Immunity	EN55024:2010+A1:2015, EN61000-6-1:2007, EN61204-3:2000, IEC61000-4-2,3,4,5,6,8,11					
Electrostatic Discharge (ESD)	IEC 61000-4-2:2008, Air Discharge: $\pm 8\text{kV}$ Contact Discharge: $\pm 4\text{kV}$					Criterion A
Radio-Frequency, Continuous Radiated Disturbance	IEC 61000-4-3:2010					Criterion A
Electrical Fast Transient (EFT)	IEC 61000-4-4:2012, $\pm 0.5\text{kV}$, $\pm 1\text{kV}$					Criterion A
Surge	IEC 61000-4-5:2014+A1:2017, L-N: $\pm 0.5\text{kV}$, $\pm 1\text{kV}$, L-E (Ground): $\pm 0.5\text{kV}$, $\pm 1\text{kV}$, $\pm 2\text{kV}$					Criterion A
Conducted Disturbances, Induced by RF Fields	IEC 61000-4-6:2013					Criterion A
Power Frequency Magnetic Field	IEC 61000-4-8:2009					Criterion A
Voltage Dips	IEC 61000-4-11:2004+A1:2017, Dips:30% reduction, Dips:>95% reduction					Criterion A
Voltage Interruptions	IEC 61000-4-11:2004+A1:2017,>95% reduction					Criterion B
Application Note Link	TRH160A Series App Notes					

CHARACTERISTIC CURVE

Power Derating Curve

TRH160A Derating Curve

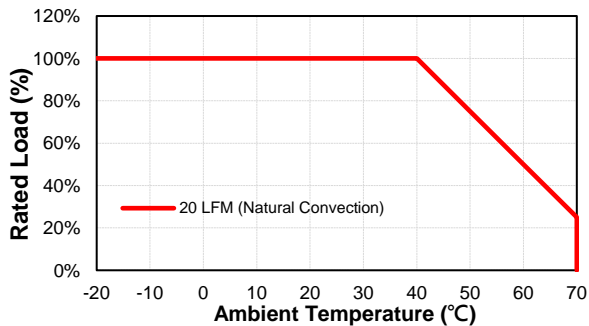

TRH160A Input Voltage Derating Curve

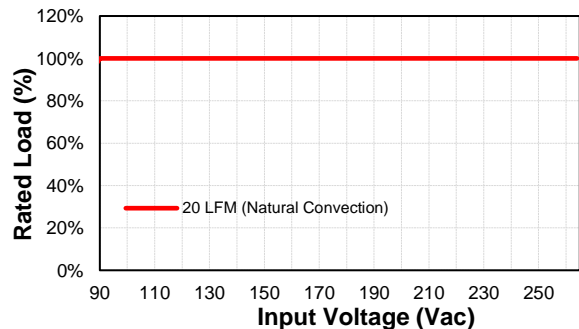

Performance Data

TRH160A120 (Eff Vs Io)

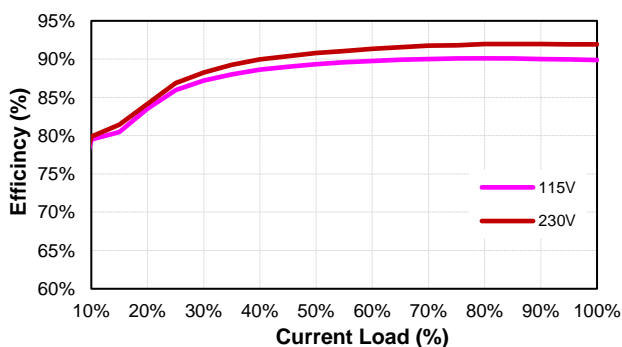

TRH160A240 (Eff Vs Io)

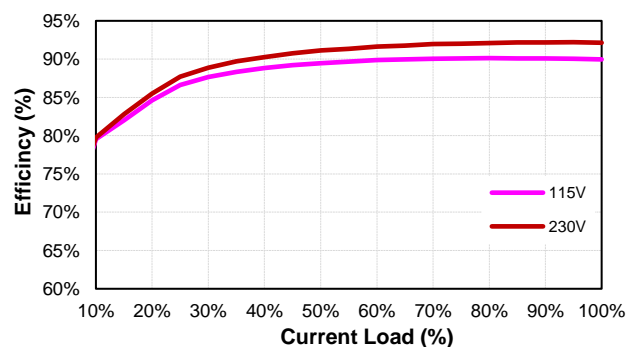



TRH160A Series

TRH160A280 (Eff Vs Io)

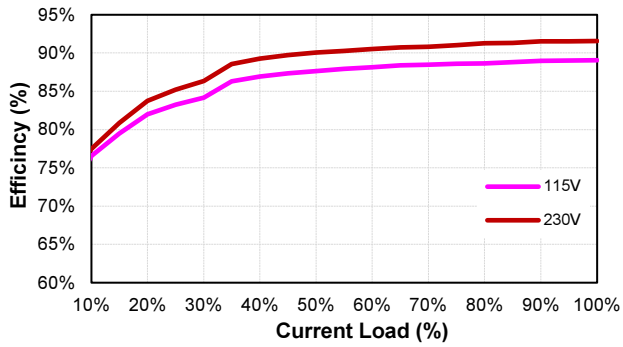

TRH160A300 (Eff Vs Io)

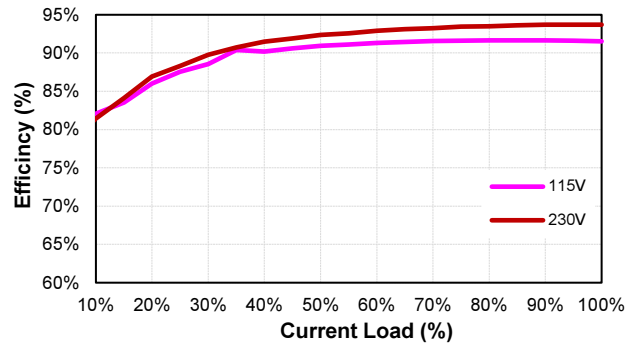

TRH160A360 (Eff Vs Io)

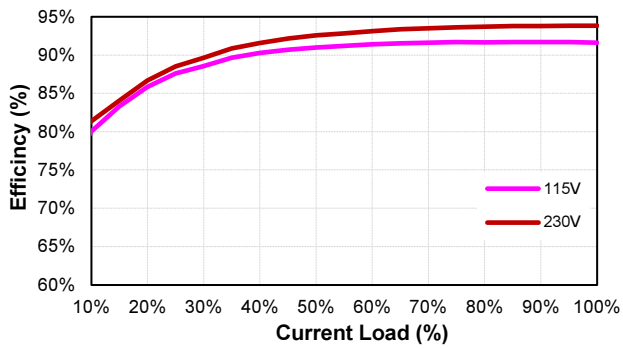

TRH160A480 (Eff Vs Io)

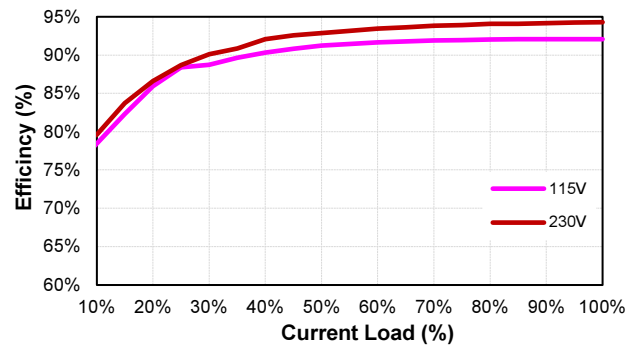

TRH160A560 (Eff Vs Io)

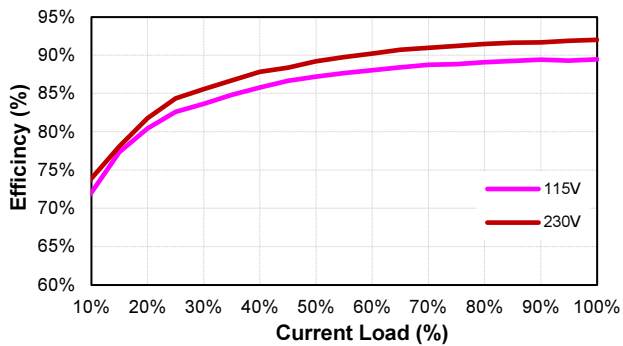



TRH160A Series

MECHANICAL SPECIFICATION

Din Power Plug

All Dimensions are in inches[mm]
 Tolerance:Inches:X.XXX±0.02
 Millimeters:X.XX±0.5
 UNIT:inches[mm]

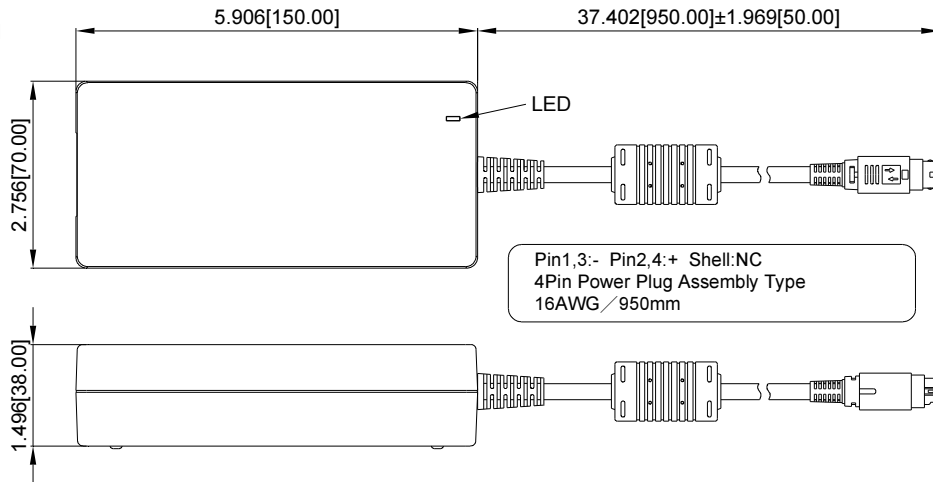
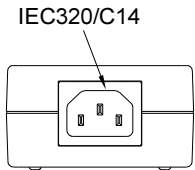

DC Jack

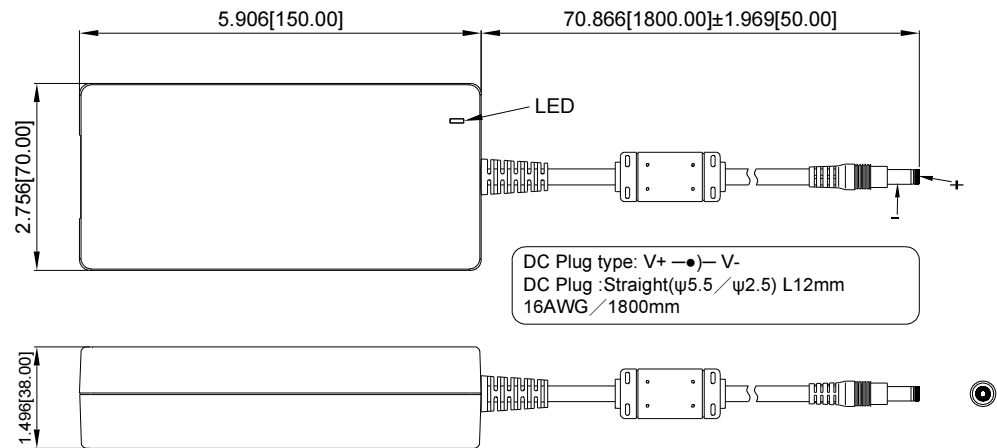
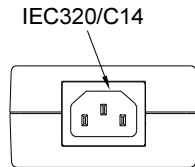

* For Output Voltage 12Vdc model, it must select Din Power Plug Molded Type or equivalent

* For Output Voltage 24Vdc to 56Vdc models, it's able to select Din Power Plug Molded Type, DC Jack or equivalent.



TRH160A Series

STANDARD OUTPUT DC PLUG

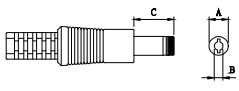
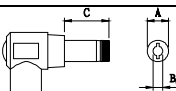
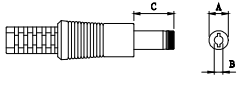
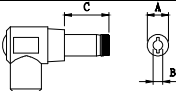
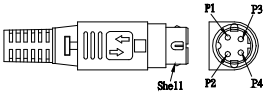
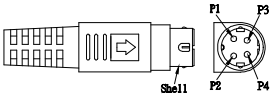
DC Plug Type	Cable Number -XXXXX	A	B	C	Cable Type	Cable Length	Cable AWG
		OD (mm)	ID (mm)	L (mm)			
 <p>Straight/Inner+Outer- + ● - -</p>	11E13	Φ5.5	Φ2.1	12	UL2464	1800mm with Ferrite Core	16AWG for 28V,30V,36V, 48V,56V
	12E13	Φ5.5	Φ2.5	12			
	23E13	Φ5.5	Φ2.1	9.5			
	26E13	Φ5.5	Φ2.5	9.5			
 <p>Right Angle/Inner+Outer- + ● - -</p>	01E13	Φ5.5	Φ2.1	12			
	02E13	Φ5.5	Φ2.5	12			
	21E13	Φ5.5	Φ2.5	9.5			
	24E13	Φ5.5	Φ2.1	9.5			
 <p>Straight/Inner+Outer- + ● - -</p>	11E12	Φ5.5	Φ2.1	12	UL2464	1220mm with Ferrite Core	16AWG for Vo: 24V
	12E12	Φ5.5	Φ2.5	12			
	23E12	Φ5.5	Φ2.1	9.5			
	26E12	Φ5.5	Φ2.5	9.5			
 <p>Right Angle/Inner+Outer- + ● - -</p>	01E12	Φ5.5	Φ2.1	12			
	02E12	Φ5.5	Φ2.5	12			
	21E12	Φ5.5	Φ2.5	9.5			
	24E12	Φ5.5	Φ2.1	9.5			
Din Plug Type	Cable Number -XXXXX	Pin Assignment		Cable Type	Cable Length	Cable AWG	
		PIN No.	Polarity				
KYCON KPPX-4P equivalent with Lock (Din Power Plug Assembly Type) 	1446E471	P1	-	UL2464	950mm with Ferrite Core	16AWG for Vo: 12V	
		P2	+				
		P3	-				
		P4	+				
		Shell	No Connection				
KYCON KPPX-4P equivalent without Lock (Din Power Plug Molded Type) 	1538E471	P1	+				
		P2	+				
		P3	-				
		P4	-				
		Shell	No Connection				

※Other DC Plug Type please refer to the link: <https://www.cincon.com/productdownload/TRH160A-cable-DC-plug.pdf>