



Hi-Rel LIMITOR MODULE LGDS-100 : up to 100W POWER

Hi-Rel Grade ■■■

Transient 100V and 200V Protection Module DEF-STAN 61-5 Part 6 & MIL-STD-1275 Metallic Case

- Ultra compact limiter module
- Transient suppressor module 202V
 - DEF-STAN-61-5 Part 6 Issue 6,
- Transient suppressor module 100V
 - MIL-STD-1275A/B/C/D,
- Transient suppressor module 80V
 - MIL-STD-704A/D/E/F, EN2282, AIR2021E
 - D0160E cat A, B and Z
- Power range : up to 90W/100W
- Inrush current limitation
- RoHS process



1- General

The GAIA Converter limiter LGDS-100 is an ultra compact power adaptor module designed to allow operation during voltage transients and spikes, occurring in avionics or military systems. The LGDS-100 delivers an output voltage adapted to GAIA Converter DC/DC modules. This module is optimized to provide high power efficiency up to 98%.

The LGDS-100 features 3 modes of operations as follow:

• **Normal operation :**

Normal operation occurs in between the permanent input voltage of the DC/DC converter; The LGDS-100 is then operating in steady transparency state.

• **Power fail operation :**

The power fail operation occurs when the input bus drops below 9 Vdc low voltage limit ; an undervoltage lock-out stops the LGDS-100.

• **Transient operation :**

The LGDS-100 clamps input transient up to 202V/350ms, or 101V/400ms.

The LGDS-100 series is compliant with the international input bus standards :

- DEF-STAN-61-5 Part 6 Issue 6
- MIL-STD-1275A/B/C/D
- MIL-STD-704A/D/E/F
- AECMA EN2282
- GAM-EG13B/AIR2021E
- D0160E cat A, B and Z

The design has been carried out with surface mount components and is manufactured in a fully automated process to guarantee high quality. Every module is tested with a Gaia Converter automated test equipment. The modules are potted with a bi-component thermal conductive compound and packaged in a metallic case to ensure the module's integrity under severe environmental conditions.

4

2- Product Selection

LGDS - 100 - - /

Input Voltage Range
Transient P : 202V/350ms

Output
K

Options :

- /T : option for -55°C start up operating temperature
- /S : option for screening and serialization

3- Modes of Operation

3-1 LGDS-100 Modes of Operation

The LGDS-100-P-K operates with H input family of GAIA Converter DC/DC Converters.

The LGDS-100-P-K features 3 modes of operations as described in the following state diagram :

• Normal operation :

Normal operation occurs in between 9V and 42V input voltage; the module is then operating in steady transparency state.

• Power fail operation :

When a failure occurs such as an undervoltage, an over current or an over temperature, the LGDS-100 turns to power fail mode and stops operation until the failure is removed. The LGDS-100 features 3 protection functions : input undervoltage lockout (UVLO), output over current protection (OCP) and over temperature protection (OTP).

• Transient operation :

When a surge occurs, the LGDS-100 turns to transient mode operation. It clamps input transient up to 202V as long as 350ms and 101V during 400ms, while the output voltage remains at 42V.

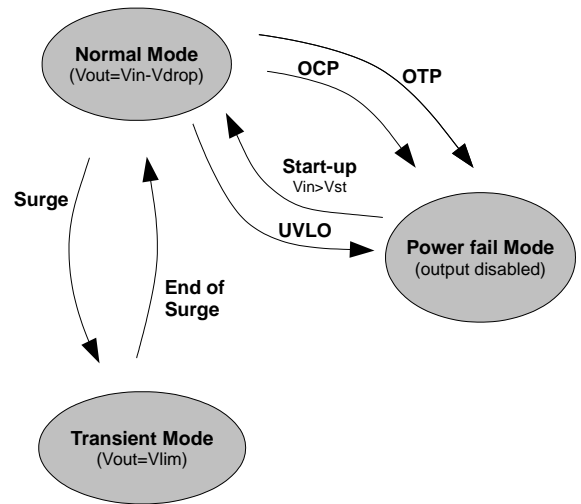

OTP : Over Temperature Protection
OCP : Over Current Protection

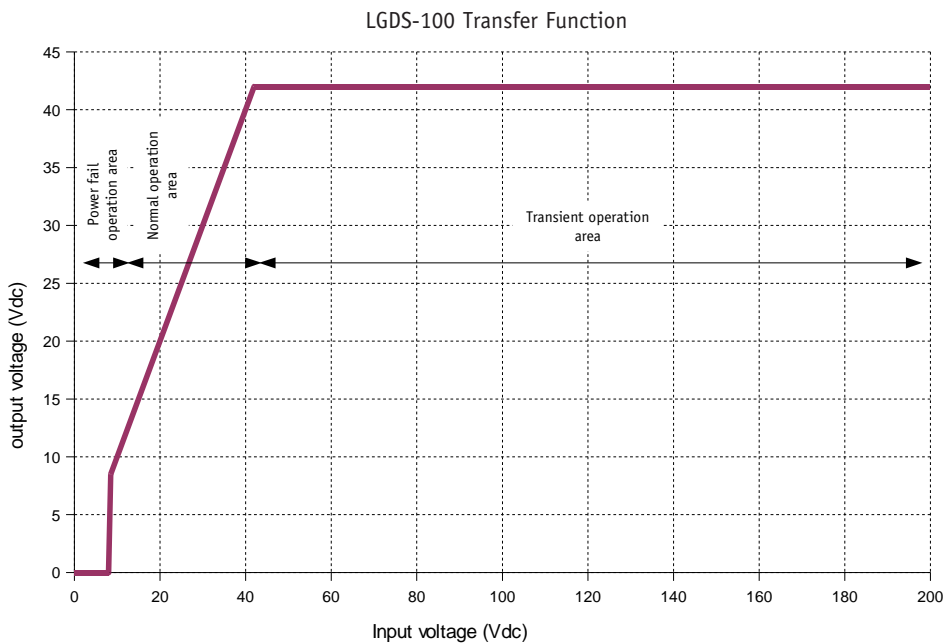

4- Electrical Specifications

Data are valid at +25°C, unless otherwise specified.

Parameter	Conditions	Limit or typical	Units	LGDS-100
Input				
Permanent input voltage range (Ui) in normal operation	Full temperature range	Minimum	VDC	9
	Full load	Maximum	VDC	42
Compliance with standards voltage transient limit	Full temperature range	Maximum	VDC/ms	202V/350ms
		Maximum	VDC/s	48V/1s
		DEF-STAN-61-5-6-6	202V/350ms	Compliant
		DEF-STAN-61-5-6-6	101V/400ms	Compliant
		MIL-STD-1275A/D	100V/50ms	Compliant
		MIL-STD-704A/F	80V/75ms	Compliant
		AECMA EN2282	60V/50ms	Compliant
		AIR2021E	60V/100ms	Compliant
DO160E cat A/Z	80V/100ms	Compliant		
Compliance with standards voltage spike limit *with filter (see 8) ** with companion filter FGDS series	50 Ohms impedance	DEF-STAN-61-5-6-6	228V/0,2µs	Compliant*
	15 mJ energy content	MIL-STD-1275A/D	250V/70µs	Compliant**
	50 Ohms impedance	MIL-STD-704A/F	600V/10µs	Compliant**
	50 Ohms impedance	AECMA EN2282	400V/100µs	Compliant**
	50 Ohms impedance	AIR2021E	600V/10µs	Compliant**
50 Ohms impedance	DO160E cat A/Z	600V/10µs	Compliant**	
Under voltage lock- out (UVLO)	Turn-on/Turn-off threshold	Minimum	VDC	7
		Maximum	VDC	9
Start up time	Ui nominal 28V Full load	Maximum	ms	6
Inrush current limitation	Full temperature range C=1000µF	Typical	A	5
No load input current	Ui nominal 28V No load	Maximum	mA	10
Output				
Nominal voltage in normal operation	Ui < 42V Full load	Minimum	/	Ui - 125mV
Nominal voltage in transient protection mode	In transient Input voltage range	Minimum	VDC	40
		Nominal	VDC	42
		Maximum	VDC	44
Output voltage slew rate	During start-up time	Typical	VDC/ms	5
Output current	Full temperature range Ui min. to max.	Maximum	A	10 (or 100W)
Output Power	Full temperature range Ui min. to max.	Maximum	W	see page 4 figure 3
Power dissipation	Ui nominal 28V Output current 10A	Maximum	W	1,55

4- Electrical Characteristics (continued)

Figure 1 : LGDS-100-P-K Transient Response at 202Vdc (according to DEF-STAN-61-5 Part 6 Issue 6)

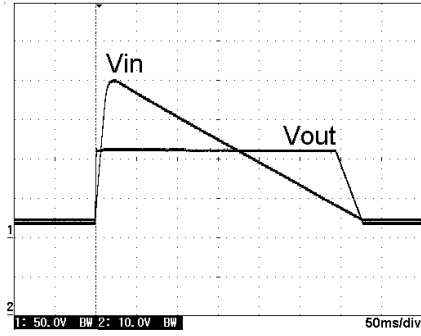

Figure 2 : LGDS-100-P-K Transient Response at 100Vdc (according to MIL-STD-1275D)

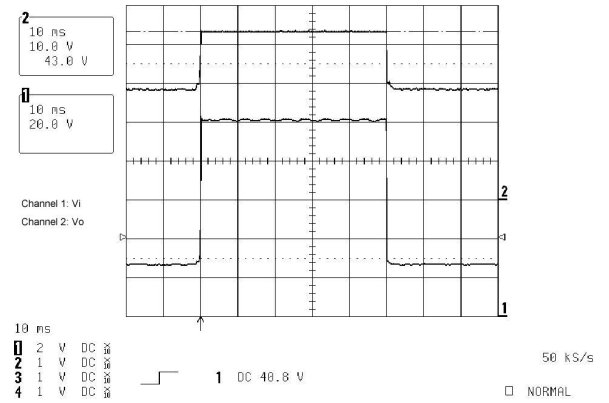

Figure 3 : LGDS-100-P-K Output Power versus Input Voltage @ Tcase max. for DEF-STAN 61-5 part 6 Issue 6

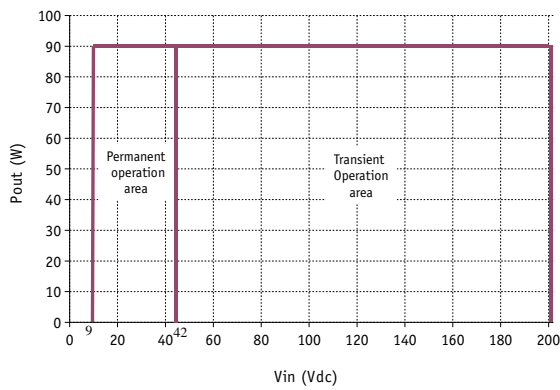
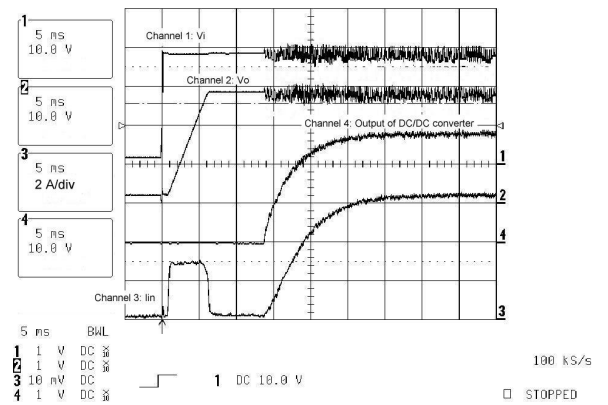

Figure 4 : LGDS-100-P-K Start-up Timing



5- Isolation

Parameter	Conditions	Limit or typical	Specifications
Electric strength test voltage	Input to output All pins to case	/ Minimum	No isolation 500 VDC / 1 min
Isolation resistance	50 VDC, all pins to case	Minimum	100 MOhm

6- Protection Functions

Characteristics	Protection Device	Recovery	Limit or typical	Specifications
Output over current protection (OCP)	Hiccup circuitry with auto-recovery	Automatic recovery	Permanent	See section 10
Over temperature protection (OTP)	Thermal device with hysteresis cycle	Automatic recovery	Nominal	120°C

4

7- Reliability Data

Characteristics	Conditions	Temperature	Specifications
Mean Time Between Failure (MTBF) According to MIL-HDBK-217F	Ground fixed (Gf)	Case at 40°C Case at 85°C	1 300 000 Hrs 425 000 Hrs
	Airborne, Inhabited, Cargo (AIC)	Case at 40°C Case at 85°C	675 000 Hrs 250 000 Hrs
Mean Time Between Failure (MTBF) According to IEC-62380-TR	Civilian avionics, calculators	Ambient at 55°C 100% time on	1 800 000 Hrs

8- Electromagnetic Interference

Electromagnetic interference requirements for an architecture using LGDS-100 and GAIA Converter DC/DC module according to DEF STAN 59-411 or MIL-STD-461D/E/F or DO-160D/E/F can be easily achieved as indicated in the following table with the use of an additional external filter as suggested hereafter.

Standards	DEF STAN 59-411	DO-160D	MIL-STD-461E	Compliance
Conducted emission (CE) : Low frequency High frequency	DCE01	Section 21	CE 101 CE 102	compliant module stand alone compliant with additional filter
Conducted susceptibility (CS) : Low frequency High frequency	DCS01 DCS02	Section 20	CS 101 CS 114	compliant with additional filter compliant with additional filter
Radiated emission (RE) : Magnetic field Electrical field	DRE02 DRE01	Section 21	RE 101 RE 102	compliant module stand alone compliant module stand alone
Radiated susceptibility (RS) : Magnetic field Electrical field	DRS01 DRS02	Section 20	RS 101 RS 013	compliant module stand alone compliant module stand alone

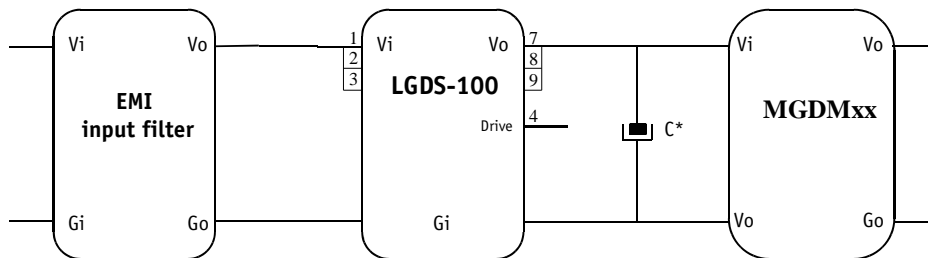

Note on C* : for stability purpose recommends the use of a 220µF/50V capacitor after the LGDS-100.

EMI Input Filter

The LGDS-100 is compliant with :

- GAIA converter ready-to-use EMI filter LGDS series for any MIL-STD-461D/E/F, DO-160D/E/F requirements, (see FGDS datasheet for details).
- specific component design EMI filter for compliance with DEF STAN 59-411 requirements and DEF-STAN 61-5 transient levels (see figure hereafter).

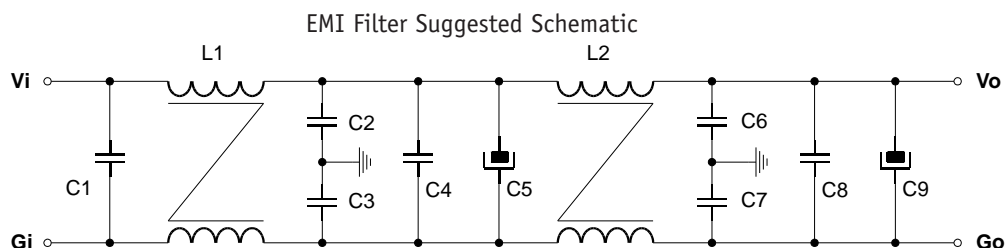

Recommended list of components :

- L1, L2 : Common mode choke 590µH current 5,6A (type Pulse P0353 or other common mode choke with higher value than 250µH and rated according to maximum current)
- C1..... : Ceramic chip capacitors 2 x 2.2µF/100V 1210 (example Murata GRM32ER71H475KA88 or other ceramic chip capacitors connected in parallel with an equivalent total value)
- C2, C3, C6, C7..... : Film chip capacitor 10 nF/500V (example AVX : 1206 7 C 103 M)
- C4 ,C8 : Ceramic chip capacitors 10 x 2.2µF/100V 1210 (example Murata GRM32ER71H475KA88 or other ceramic chip capacitors connected in parallel with an equivalent total value)
- C5, C9 : Tantalum or aluminium electrolytic capacitor 47 to 100µF/250V (with low ESR)

9- Thermal Characteristics

Characteristics	Conditions	Limit or typical	Performances
Operating ambient temperature range at full load	Ambient temperature *	Minimum Maximum	- 40°C + 85°C
Operating case temperature range at full load	Case temperature	Minimum Maximum	- 40°C +105°C
Storage temperature range	Non functioning	Minimum Maximum	- 55°C + 125°C
Thermal resistance	Rth case to ambient in free air natural convection	Typical	12°C /W

Note * : The upper temperature range depends on configuration, the user must assure a max. case temperature of + 105°C.

The LGDS-100 series operating **case** temperature at full load must not exceed 105°C. The maximum **ambient** temperature admissible for the DC/DC converter corresponding to the maximum operating case temperature of 105°C depends on the ambient airflow, the mounting/orientation, the cooling features and the power dissipated.

To calculate a maximum admissible ambient temperature the following method can be used. Knowing the maximum case temperature Tcase = 105°C of the module, the power used Pout and the efficiency η :

- determine the power dissipated by the module P_{diss} that should be evacuated :

$$P_{diss} = P_{out}(1/\eta - 1)$$

- determine the maximum ambient temperature :

$$T_a = 105^\circ\text{C} - R_{th} \times P_{diss}$$

where **Rth** is the thermal resistance from the case to ambient.

The previous thermal calculation shows two areas of operation :

- a normal operation area in a free natural ambient convection (grey area in the following graph),
- an area with cooling features (air flow or heatsink) ensuring a maximum case temperature below the maximum operating case temperature of 105°C at full load (white area in the following graph).

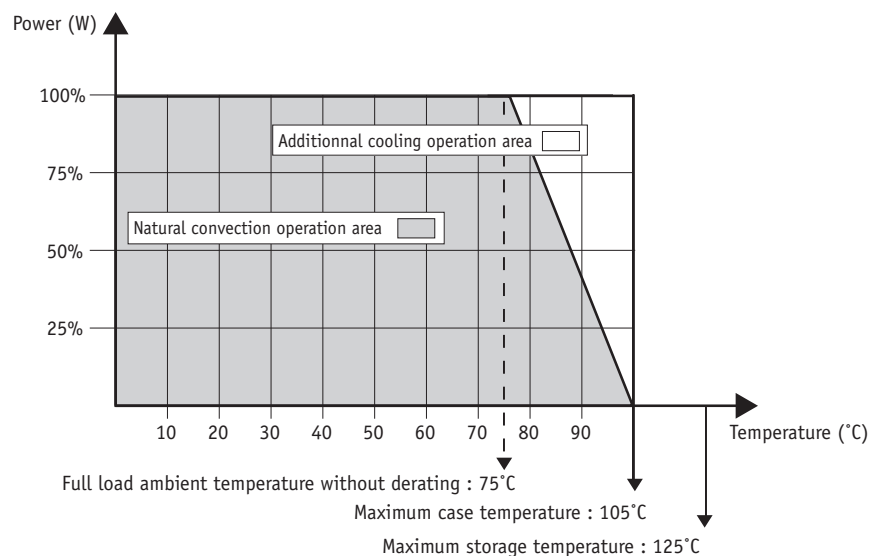

10- Environmental Qualifications

The modules have been subjected to the following environmental qualifications.

Characteristics	Conditions	Severity	Test procedure
Climatic Qualifications			
Life at high temperature	Duration Temperature / status of unit	Test D : 1 000 Hrs @ 125°C ambient, unit not operating	MIL-STD-202G Method 108A
Altitude	Altitude level C Duration Climb up Stabilization Status of unit	40 000 ft@-55°C 30 min. 1 000 ft/min to 70 000 ft@-55°C, 30 min. unit operating	MIL-STD-810G Method 500.5
Humidity cyclic	Number of cycle Cycle duration Relative humidity variation Temperature variation Status of unit	10 Cycle I : 24 Hrs 60 % to 88 % 31°C to 41°C unit not operating	MIL-STD-810G Method 507.5
Humidity steady	Damp heat Temperature Duration Status of unit	93 % relative humidity 40°C 56 days unit not operating	MIL-STD-202G Method 103B
Salt atmosphere	Temperature Concentration NaCl Duration Status of unit	35°C 5 % 48 Hrs unit not operating	MIL-STD-810G Method 509.5
Temperature cycling	Number of cycles Temperature change Transfert time Steady state time Status of unit	200 -40°C / +85°C 40 min. 20 min. unit operating	MIL-STD-202A Method 102A
Temperature shock	Number of shocks Temperature change Transfert time Steady state time Status of unit	100 -55°C / +105°C 10 sec. 20 min. unit not operating	MIL-STD-202G Method 107G
Mechanical Qualifications			
Vibration (Sinusoidal)	Number of cycles Frequency / amplitude Frequency / acceleration Duration Status of unit	10 cycles in each axis 10 to 60 Hz / 0,7 mm 60 to 2 000 Hz / 10 g 2h 30 min. per axis unit not operating	MIL-STD-810G Method 514.6
Shock (Half sinus)	Number of shocks Peak acceleration Duration Shock form Status of unit	3 shocks in each axis 100 g 6 ms 1/2 sinusoidal unit not operating	MIL-STD-810G Method 516.6
Bump (Half sinus)	Number of bumps Peak acceleration Duration Status of unit	2 000 Bumps in each axis 40 g 6 ms unit not operating	MIL-STD-810G Method 516.6

11- Description of Protections

The LGDS-100 includes 3 types of protection devices.

11-1 Output Over Current Protection (OCP)

The LGDS-100 provides a circuit breaker function that latches the output off if the load current exceeds the current limit threshold for a duration. The circuit breaker function automatically attempts to restart power after a load current fault at a low duty cycle to prevent the LGDS-100 from overheating. The over current protection function protects the module against over load of any duration and restores the module to normal operation when the over load is removed. It operates in «hiccup» mode by testing periodically if an overload is applied (typically every 1s recovery time). The overload detection threshold is typically 19A with a detection time lower than 5ms.

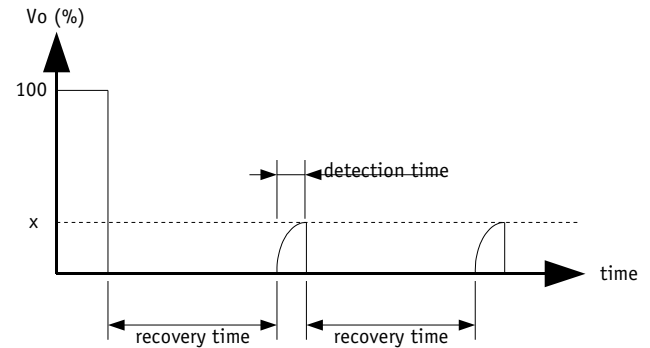

11-2 Inrush Current Limitation

The inrush current limitation function operates by limiting the output voltage ramp up. It is internally set at 5V/ms typically. The inrush current is calculated as follow.

$$I_{inrush} = C_{out} \times \frac{dV_{out}}{dt} \text{ where :}$$

- C_{out} is the capacitor value connected to the output
- $\frac{dV_{out}}{dt} = 5V/ms$

By adding a capacitor connected across the pins «Drive» & «Gi», and in order to reduce the inrush current the value $\frac{dV_{out}}{dt}$ can be adjusted as follow :

$$\frac{dV_{out}}{dt} = \frac{50}{10 + C_{DRIVE}} V/ms \quad C_{DRIVE} \text{ is given in nF}$$

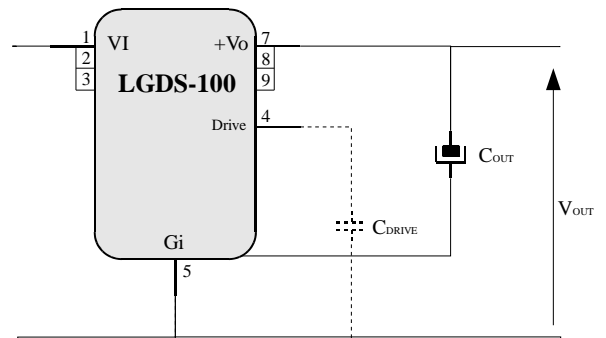

4

11-3 Over Temperature Protection (OTP)

A thermal protection device adjusted at 120°C (+/-5%) internal temperature with a 10°C hysteresis cycle will inhibit the module as long as the overheat is present and restores to normal operation automatically when overheat is removed.

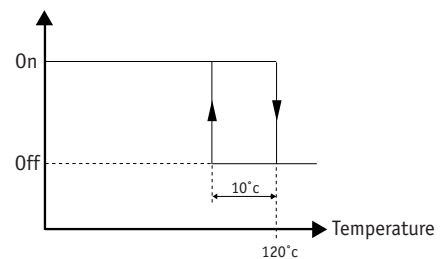

12- Application Notes

12-1 Reverse Polarity Compatibility

The LGDS-100 has been designed to be compliant with reverse polarity requirements. The reverse polarity protection can be externally achieved either by a standard solution using a schottky diode or either a low losses solution using a N channel power MOSFET. The following figures are showing both solutions.

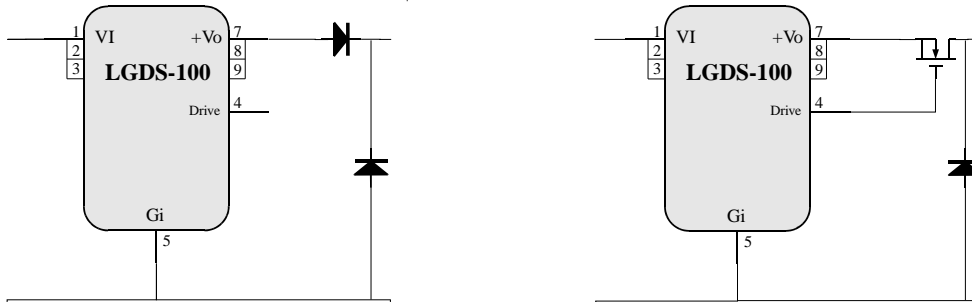

12-2 Drive Function

The LGDS-100 features a drive function used to adjust the inrush current limit during start-up phase and to achieve a low loss reverse polarity protection.

Parameter	Unit	Min.	Typ.	Max.	Notes, conditions
Drive voltage	Vdc	Vo-0.6	/	Vo+12	
Drive current					
source	μA	50	/	100	Must be externally limited
sink	μA	-1 000	/	0	

4

12-3 Typical Architecture Schematics Using LGDS-100 with Multiple Modules

The LGDS-100 is compliant for use with several DC/DC GAIA converter modules in various configurations. To meet MIL-STD-461D/E/F, DO-160D/E/F requirements, GAIA Converter recommends the use of ready-to-use EMI filter together with its R*C* cell (see EMI filter datasheet for details). For stability purpose GAIA Converter recommends the use of a 220μF/50V capacitor after the LGDS-100.

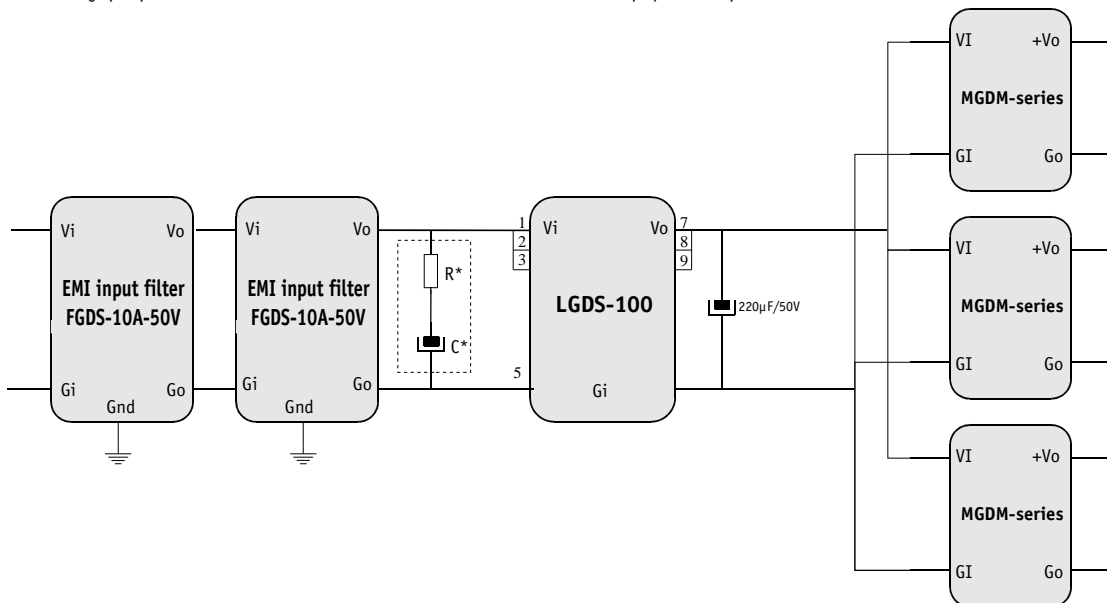

Note : such design with joint EMI filter is incompatible with reverse polarity compatibility. In such case place the second EMI filter after LGDS-100.

13- Dimensions

Dimension are given in mm. Tolerance : +/- 0,2 mm unless otherwise indicated.
 Weight : 35 grams (1.22 Ozs) max.

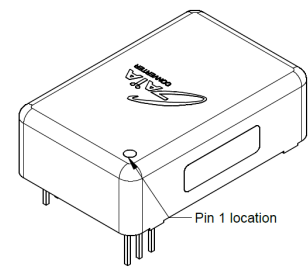
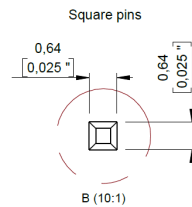
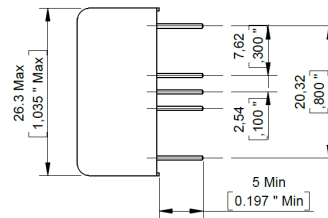
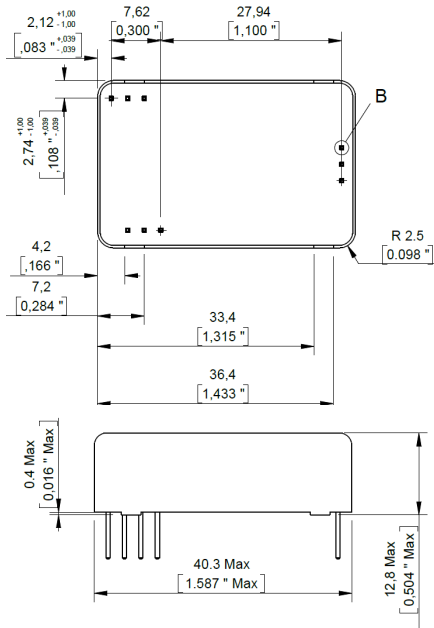

14- Materials

Case : Metallic black anodized coating.
 Pins : Plated with pure matte tin over nickel underplate.

15- Product Marking

Upper face : Company logo.
 Side face : Module reference, option, date code : year and week of manufacturing.

16- Connections

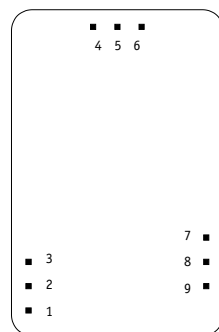

Bottom view

Pin	LGDS-100
1,2,3	+Input (Vin)
4	Drive
5	Common (Gin)
6	Not connected
7,8,9	Output (Vo)



Represented by :