

# Board to Board Connectors

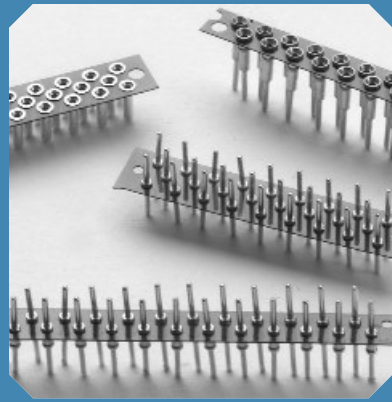

## Features:

- Supplied in high temperature Peel-A-Way® removable terminal carrier.
- Female and male connectors are designed in mating pairs.
- .050/(1.27mm) row to row pitch.
- High reliability screw-machined terminals with closed-end construction for 100% anti-wicking of solder.
- Custom configurations available.

## Specifications:

### Terminals:

Brass - Copper Alloy  
(C36000) ASTM-B-16

### Contacts:

Beryllium Copper  
(C17200) ASTM-B-194



### Plating:

G - Gold over Nickel  
M - Matte Tin over Nickel  
T - Tin/Lead over Nickel

Gold per ASTM-B-488  
Matte Tin per ASTM545-97  
Tin/Lead per MIL-P-81728  
Nickel per QQ-N-290

# Staggered .050/(1.27mm) Pitch Board to Board Connectors Peel-A-Way® Insulators

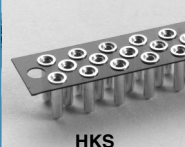
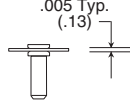
## Table of Models

	Dual Row	Triple Row		
Female	 KES	 HKS	Description: Peel-A-Way® (KES, HKS) Material: Polyimide Film Index: -269°C to 400°C (-452°F to 752°F)	 .005 Typ. (.13)
	 KEA	 HKA		

## Dimensional Information

### Dual Row (ex. KES015-)

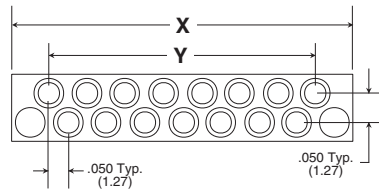

# of Pins Total	X in. (mm)	Y in. (mm)
5	.400 (10.16)	.200 (5.08)
9	.600 (15.24)	.400 (10.16)
15	.900 (22.86)	.700 (17.78)
19	1.100 (27.94)	.900 (22.86)
25	1.400 (35.56)	1.100 (27.94)

### Triple Row (ex. HKS020-)

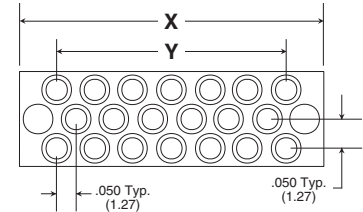

# of Pins Total	X in. (mm)	Y in. (mm)
8	.400 (10.16)	.200 (5.08)
14	.600 (15.24)	.400 (10.16)
20	.800 (20.32)	.600 (15.24)
26	1.000 (25.40)	.800 (20.32)
35	1.300 (33.02)	1.100 (27.94)

## How To Order

### Female

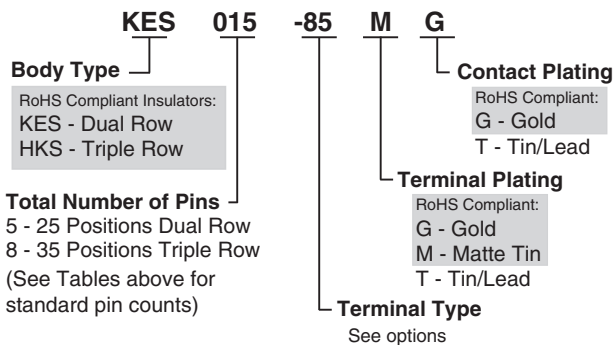

### Male

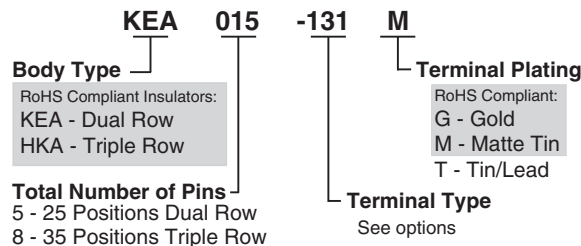

Note: Terminals plated with Matte Tin are available only with Gold plated contacts.

Products shown covered by patents issued and/or pending. Specifications subject to change without notice.

inch/(mm)



5 Energy Way, West Warwick, RI 02893 USA  
Tel: 800.424.9850 | 401.823.5200  
Fax: 401.823.8723  
info@advanced.com | www.advanced.com  
Catalog 16A Rev. 1

# Staggered .050/(1.27mm) Pitch Board to Board Connectors Peel-A-Way® Insulators

# Board to Board Connectors

## Standard Female Terminals

Additional standard and custom terminals available.  
See Terminals section or consult factory.

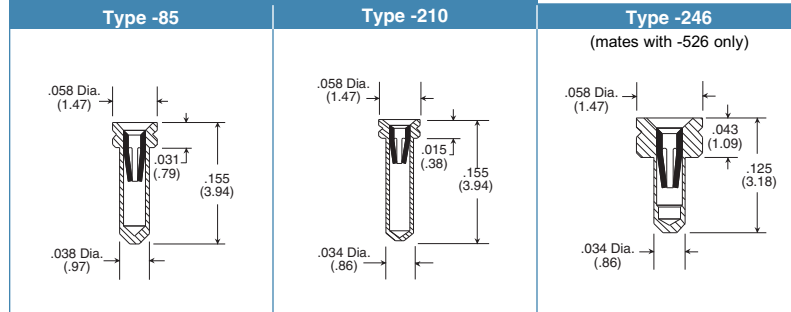

## Standard Male Terminals

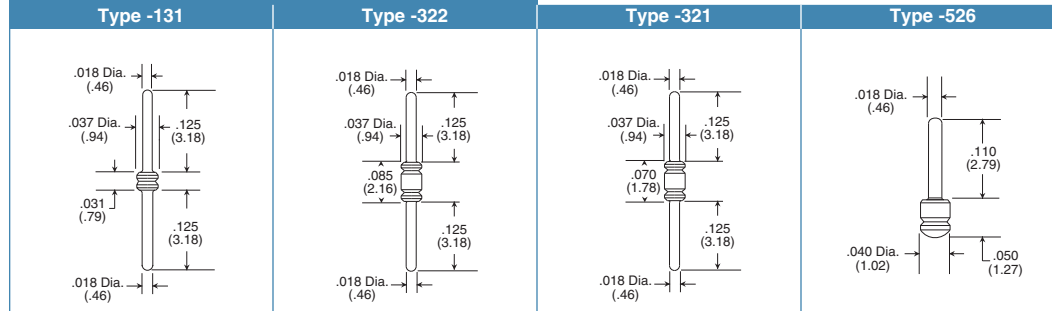

## Dimensional Information

**Figure 1**  
Thru-Hole

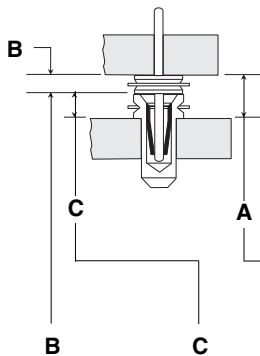

**Figure 2**  
Surface Mount

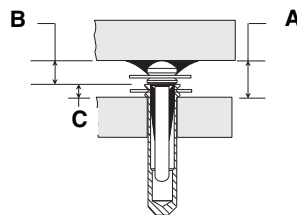

Order one each Male & Female  
to get the required "A" dim.

B	C	A	Male Part #	Female Part #	Fig. #
.031/(.79)	.015/(.38)	.046/(1.17)	KEA015-131G	KES015-210MG	1
.031/(.79)	.015/(.38)	.046/(1.17)	KEA015-525G	KES015-210MG	2
.031/(.79)	.031/(.79)	.062/(1.57)	KEA015-131G	KES015-85MG	1
.031/(.79)	.031/(.79)	.062/(1.57)	KEA015-525G	KES015-85MG	2
.050/(1.27)	.015/(.38)	.065/(1.65)	KEA015-526G	KES015-210MG	2
.050/(1.27)	.031/(.79)	.081/(2.06)	KEA015-526G	KES015-85MG	2
.070/(1.78)	.015/(.38)	.085/(2.16)	KEA015-321G	KES015-210MG	1
.050/(1.27)	.043/(1.09)	.093/(2.36)	KEA015-526G	KES015-246MG	2
.085/(2.16)	.015/(.38)	.100/(2.54)	KEA015-322G	KES015-210MG	1
.070/(1.78)	.031/(.79)	.101/(2.57)	KEA015-321G	KES015-85MG	1
.085/(2.16)	.031/(.79)	.116/(2.95)	KEA015-322G	KES015-85MG	1

15 position dual row part numbers shown.  
See How To Order section for ordering information.

If required "A" dimension is not shown, consult factory.

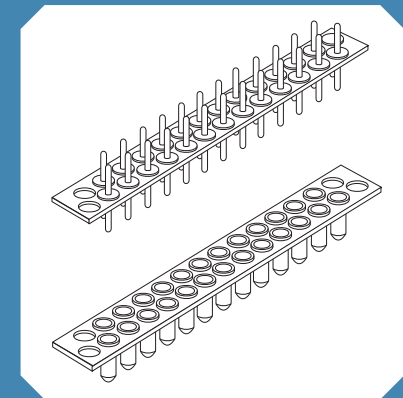
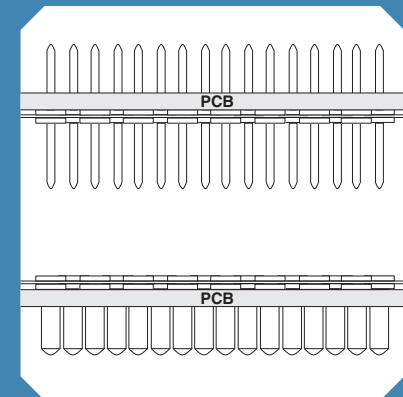

## Peel-A-Way® Removable Carriers

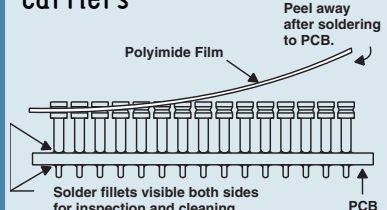

1. Place socket on PC board.
2. Send PC board and socket through soldering operation.
3. Peel away polyimide film carrier for complete solder joint visibility or leave in place for added stability.

## Available Online:

- RoHS Qualification Test Report



5 Energy Way, West Warwick, RI 02893 USA  
Tel: 800.424.9850 | 401.823.5200  
Fax: 401.823.8723  
info@advanced.com | www.advanced.com  
Catalog 16A Rev. 1

inch/(mm)

Products shown covered by patents issued and/or pending. Specifications subject to change without notice.